

# EMC Measurements on Wireless Devices

Achim Gerstner  
Senior Manager Test Systems  
Rohde & Schwarz USA, Inc.

[achim.gerstner@rsa.rohde-schwarz.com](mailto:achim.gerstner@rsa.rohde-schwarz.com)

# Agenda

- | Introduction and Smart Phone Evolution
- | Radiated RF Performance Demands
- | Specifications of “Radiated Spurious Emissions” (RSE)
  - | RSE Measurement procedure acc. to 3GPP TS51.010
  - | Measurement requirements acc. to TS51.010
  - | Test Site requirements (general RSE)
- | Radiated Immunity Measurements
  - | According to TS 34.124 (UE) and ETSI EN 301 489-7



# The Smart Phone Evolution

| **We went from this**



| **to this**



| **in basically no time**

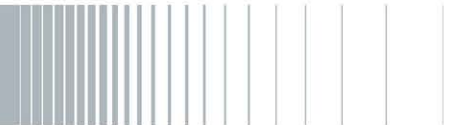

# The Smart Phone Evolution (cont.)

## I Multi-radio devices

- I Cellular: 2G, 3G, LTE, WiMAX
- I Wireless: Wi-Fi, Bluetooth
- I GPS, A-GPS
- I Mobile TV, FM radio

## I Multiple integrated functions

- I Camera
- I Interfaces (USB)
- I Touchscreen, keyboard
- I Memory cards
- I Wireless charging
- I Built-in projector
- I NFC (coming soon)

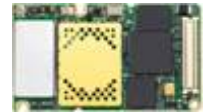

# The Smart Phone Evolution (cont.)

## Smart Phone Building Blocks

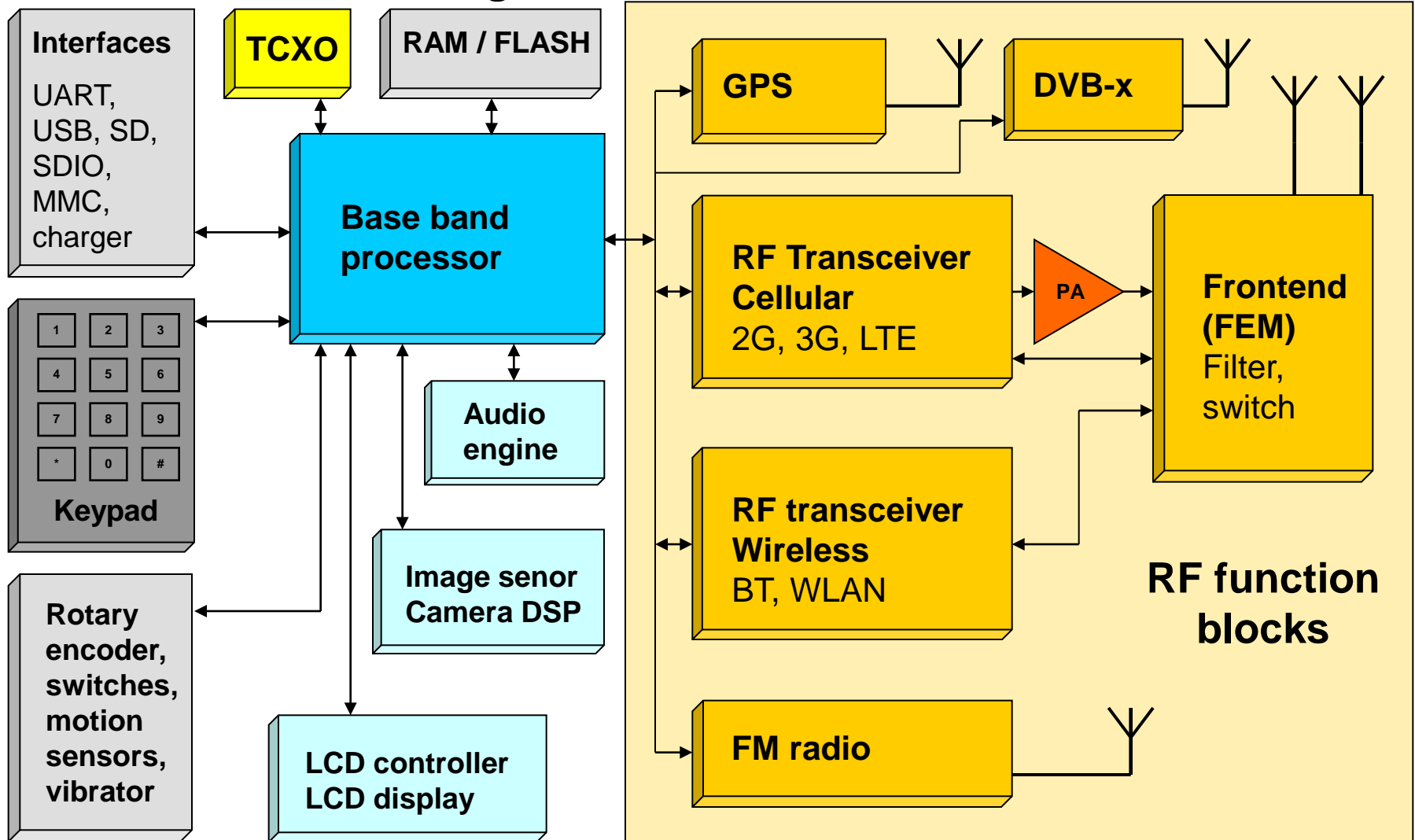

# Radiated RF Performance Demands

**Expectation of the  
network operator / service provider**

Wireless Devices incorporates  
an integral, omni-directional antenna for  
transmission and reception

- Cell planning consideration are made for:
- **Cell size**
  - **Frequency re-use**
  - **Traffic capacity**
  - **Interference**

*A bad over-the-air performance will give the  
impression of a poor radio network  
and wireless device to the user.*

## Test Methods

**Desense**

**Coexistence**

**OTA  
(TRP, TIS)**

**EMI scan**

**RSE**

**SAR**

# Radiated RF Performance Demands (cont.)

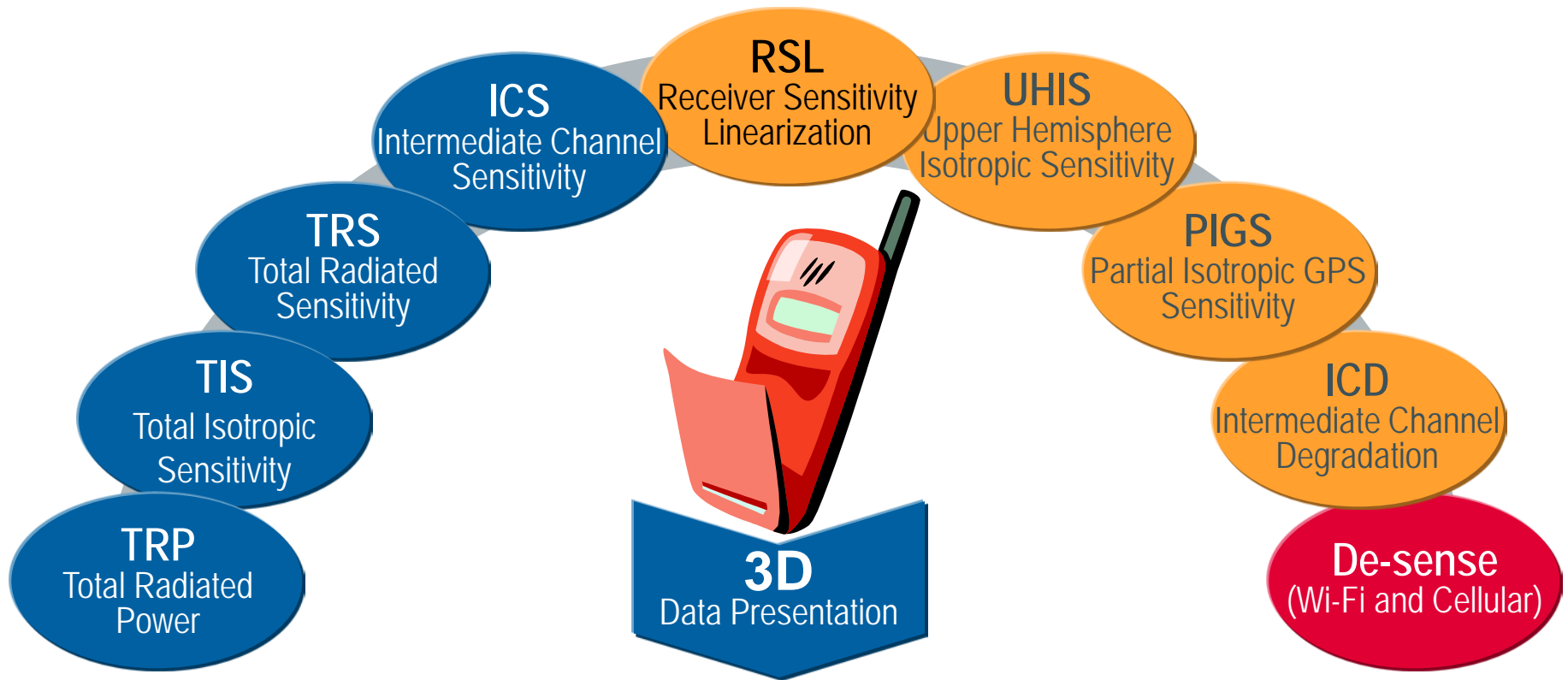

OTA / RPT Measurements

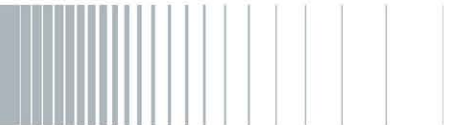

# Radiated RF Performance Demands (cont.)

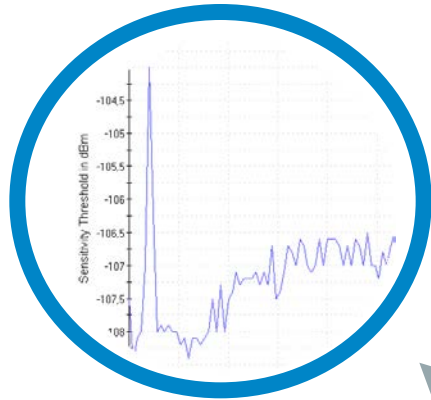

**Desense test**

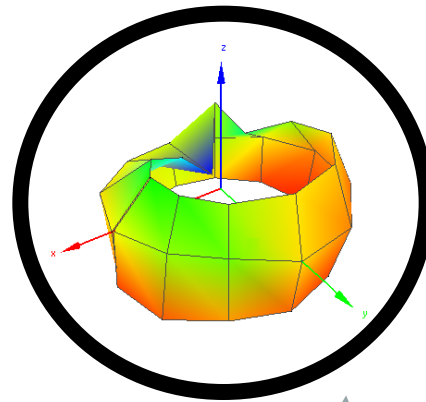

**OTA performance**

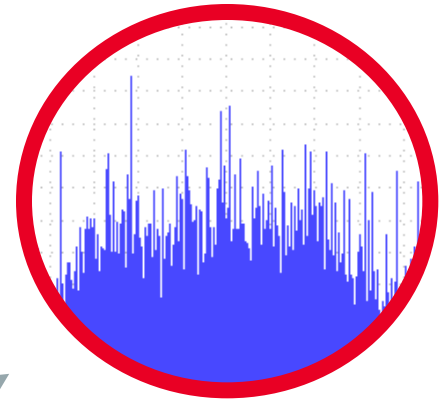

**EMI scan**

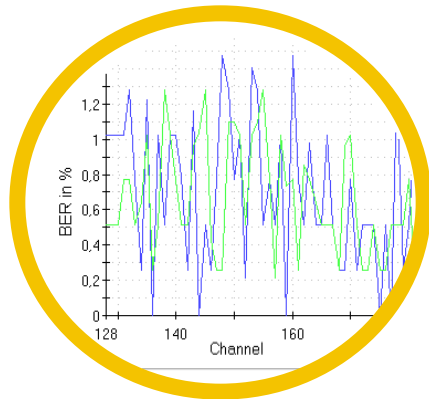

**Coexistence test**

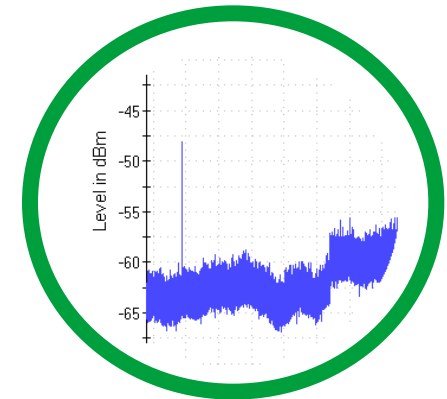
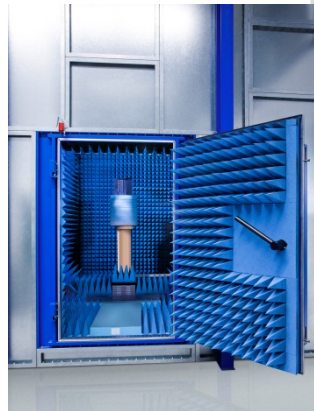

**Radiated spurious emission test**



# Radiated RF Performance Demands (cont.)

## I Terminology

### I Desense (or desensitization)

Refers to desensitization of the receiver performance of wireless devices

Effect caused by internal noise (e.g. oscillator harmonics, poor design, production errors, etc.)

→ Self interference

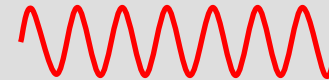

### **Impact:**

Reduced quality of service, call drops at the edge of network cells, partial blocking of channels

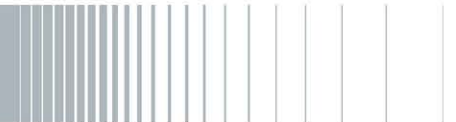

# Radiated RF Performance Demands (cont.)

## I Terminology (cont.)

### I Coexistence

Refers to simultaneous operation of multiple radios inside wireless devices (e.g. Wi-Fi, BT and cellular)

Problems caused by overlapping frequency bands

→ Sharing of resources (time, antennas)

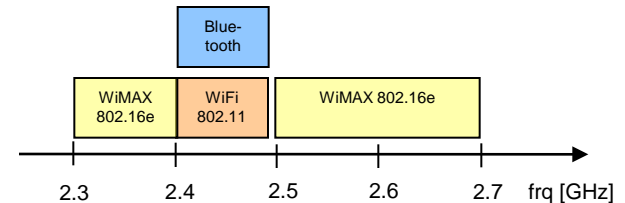

### Impact:

Reduced quality of service, lower throughput, call drops at the edge of network cells

# Radiated RF Performance Demands (cont.)

## | Sources of Self-interference

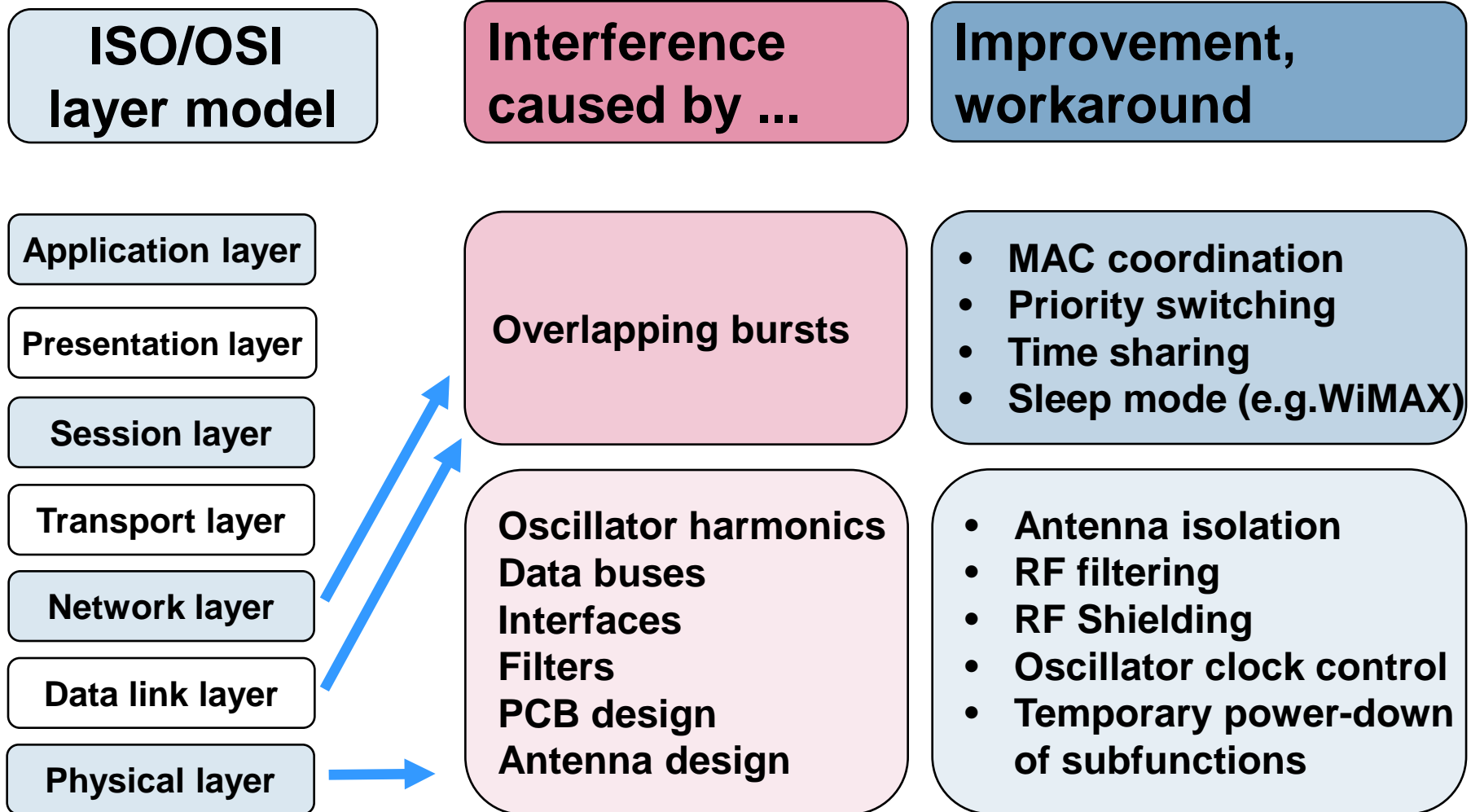

# RSE - Radiated Spurious Emission

## I Specifications for Radiated Spurious Emissions (RSE)

### I Conformance Specifications

- I TS51.010 12.2.1, 12.2.2 Mobile stations (MS) conformance specification
- I ETS EN 301 908-1
- I ETS EN 301 607-1
- I ETS EN 300 826
- I .....

### I EMC / EMI Specifications for Radio Frequency Devices

- I ETS EN 301 489      Electromagnetic compatibility and Radio spectrum Matters (ERM); Electro Magnetic Compatibility (EMC) standard for radio equipment and services  
Part 1: Common technical requirements  
Part 7: Specific conditions for mobile and portable radio and ancillary equipment of digital cellular radio telecommunications systems (GSM and DCS)
- I FCC Part 15      Radio Frequency Devices

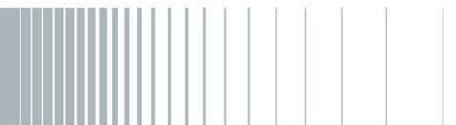

# RSE - Radiated Spurious Emission (cont.)

## I **ETS EN 301 489: Multipart Standard for Wireless Products**

- I Part 1: Common technical requirements
- I Part 2: Radio Paging Equipment
- I Part 3: Short Range Devices
- I Part 4: Fixed Radio Links
- I Part 5: Private land Mobile Radio
- I Part 6: DECT
- I Part 7: GSM and DCS
- I Part 8: GSM base stations
- I Part 9: Wireless Microphones
- I Part 10: CT1, CT1+, CT2
- I Part 11: FM BC Transmitter
- I Part 12: Earth Stationary 4 GHz to 30 GHz, Fixed Satellite Service
- I Part 13: CB radio
- I Part 15: Amateur Radio Equipment
- I Part 16: Analogue Cellular Radio
- I Part 17: Wideband data and HIPERLAN
- I Part 18: TETRA
- I Part 19: ROMES
- I Part 20: MES and MSS
- I Part 22: VHF aeronautical radios
- I Part 23: UMTS (BS)
- I Part 24: UMTS (MS)
- I Part 25: CDMA MC (MS)
- I Part 26: CDMA MC (BS)



# RSE - Radiated Spurious Emission (cont.)

- | **Spurious emission measurements according to ETSI and 47CFR15 - Definition**
  - | Emission at a frequency, or frequencies which are outside the necessary bandwidth and the level of which may be reduced without affecting the corresponding transmission of information
  - | Spurious emissions include harmonic emissions, parasitic emissions, intermodulation products and frequency conversion products but exclude out-of-band emissions
  - | Measurement of spurious emissions up to 12.75 GHz according to ETSI Standard limits for spurious emissions
  - | Measurement of interference up to the 10th harmonic according to 47 CFR FCC Rules part 15



# RSE - Radiated Spurious Emission (cont.)

- | **Test site requirements acc. TS 51.010**
- | **Test case 12.2: Radiated Spurious Emissions**
  - | This test is performed either on an outdoor test site, fulfilling the requirements of GC4 (Annex 1), or in a shielded anechoic chamber fulfilling the requirements of GC5.
  - | Performing the measurement in the shielded anechoic chamber is preferred.
  - | The measurement site may be a shielded anechoic chamber being 10 m long, 5 m broad and 5 m high. Walls, ground and ceiling should be covered with RF-Absorbers of 1 m height.
  - | Measurement distance: 3 m (up to 1 GHz), any suitable distance ( $> 1$  GHz)
  - | The size of the test antenna along the measurement axis should not exceed 20% of the measurement distance. ( 20% of 3 m = 0.6 m )
  - | EUT / substitution antenna 1.5 m height
  - | Test antenna height between 1 and 4 m



# RSE - Radiated Spurious Emission (cont.)

- | **Test case 12.2: Radiated Spurious Emissions (cont.)**
  - | The substitution antenna shall be a half-wave dipole, or a shortened dipole, or (above 1 GHz) a horn radiator. Antennas other than a half-wave dipole shall have been calibrated to the half-wave dipole.
  - | The center of the antenna shall coincide with the reference point of the test sample





# RSE - Radiated Spurious Emission (cont.)

## I Test Site Requirements

### I Open Area Test Site (OATS)

- Ground plane
- measurement distance: 3m (up to 1GHz), any suitable distance (> 1GHz)
- equipment size < 20% of measuring distance
- EUT / substitution antenna 1.5 m height
- test antenna height varies between 1 and 4 m

### I Fully Anechoic Room (FAR)

- test setup similar to open area test site
- fully anechoic chamber with floor absorbers allowed
- no height variation -> simplifies method of measurement

### I Antenna Requirements

- Test antenna: size shall not exceed 20% of measurement distance
- substitution antenna: dipole (tuned, or shortened) and horn radiator



# RSE - Radiated Spurious Emission (cont.)

## I Conformant RSE Test Site

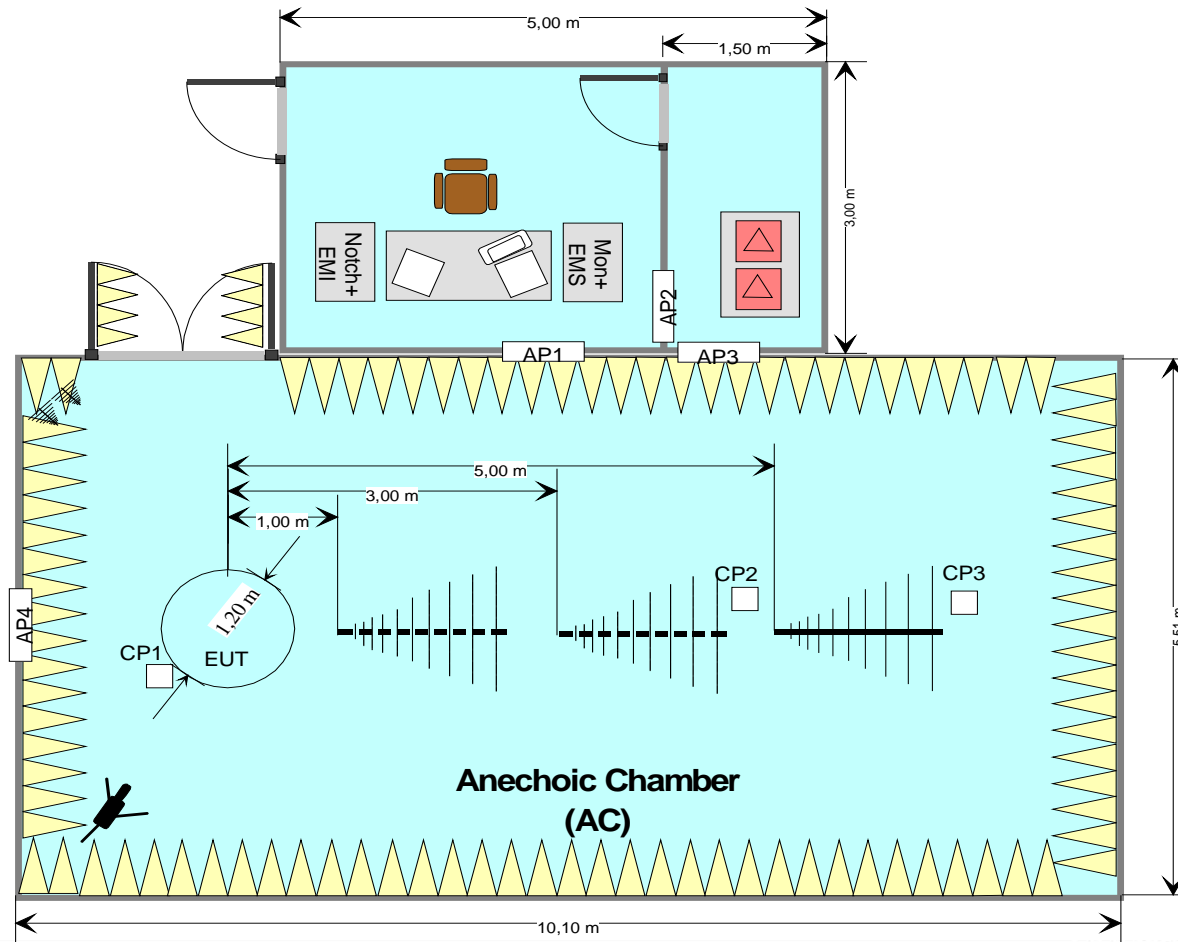

# RSE - Radiated Spurious Emission (cont.)

## I **RSE Measurement Procedure TS51.010**

- I As an initial step to identify the spurious emissions in the frequency range of 30 MHz to 4 GHz, the measurement antenna is positioned closely to the DUT
- I Once all substantial emissions are found the antenna is placed at the appropriate measurement distance, by rotating the device the maximum effective radiated power of the emission has to be measured at both orthogonal measurement antenna positions
- I The maximum radiated power should be determined by substitution measurement
- I If an anechoic chamber is used for the measurement the use of pre-calibrated data for the determination is allowed



# RSE - Radiated Spurious Emission (cont.)

## I **RSE Measurement Procedure TS51.010 (cont.)**

- I To ensure that the active and the quiet time of the transmitting MS is measured, the measurement should be performed at least for one TDMA frame period
- I The measurement bandwidth based on a 5 pole synchronously tuned filter is set according to table 12.8.
- I Depending on the gain of the test antenna the noise floor may rise above the limits to compensate this effects the adjustment of the system bandwidth is permitted. As an alternative the reduction of the measurement distance down to 1 m is permitted for frequencies above 900 MHz
- I All tests have to be repeated under extreme voltage conditions



# RSE - Radiated Spurious Emission (cont.)

## | Overview 2G/3G/4G in regards to RSE

### | 2G, GSM

- | Up to +33dBm radiated power
- | Time division multiplexing, 8 time slots
- | 200 kHz channel bandwidth
- | RSE measured up to 4 GHz
- | 4 Bands



Measurement challenges:	Solution:
High power combined with low S/N	Notch filter
TDMA with 8 time slots	Appropriate setting of sweep times
Channel bandwidth	Bandwidth according to standard
Measurement 30 MHz to 4 GHz	2 antennas: LPD + horn antenna
4 Bands	Switch matrix with 4 different notch filters

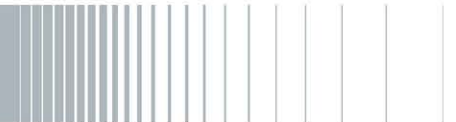

# RSE - Radiated Spurious Emission (cont.)

## | Overview 2G/3G/4G in regards to RSE

### | 3G, UMTS

- | Up to +27dBm radiated power
- | 5 MHz channel bandwidth
- | RSE measured up to 12.75 GHz
- | 15 Bands



<b>Measurement challenges:</b>	<b>Solution:</b>
<b>Medium power combined with low S/N</b>	<b>Notch filter</b>
<b>Channel bandwidth</b>	<b>Bandwidth according to standard</b>
<b>Measurement 30 MHz to 12.75 GHz</b>	<b>2 antennas: LPD + horn antenna with integrated LNA above 6 GHz</b>
<b>15 Bands</b>	<b>switch matrix with up to 15 different notch filters. Some bands overlapping or not in use</b> ⇒ <b>Normally 9 bands</b>

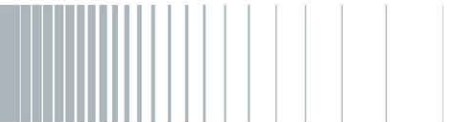

# RSE - Radiated Spurious Emission (cont.)

## | Overview 2G/3G/4G in regards to RSE

## | 4G, LTE

- | Up to +24dBm radiated power
- | Dynamic channel bandwidth, 1.4, 3, 5, 10, 15, 20 MHz
- | RSE measured up to 12.75 GHz
- | 43 Bands as of today



## | Measurement challenges:

- | Measurement up to 12.75 GHz
- | Solution: use of horn antenna and LNA - Low Noise Amplifier above ~6 GHz
  
- | Major challenge 43 bands, 6 channel bandwidths !!!  
**This would mean 258 notch filters in a traditional setup**



# RSE - Radiated Spurious Emission (cont.)

## I **Measurement method for spurious emissions**

- I Use of a selective receiver or spectrum analyzer required
  - Mean and peak weighting functions
  - Resolution bandwidth given as 3 dB BW - should be equal to reference bandwidth
  - Video bandwidth: at least as large as resolution bandwidth – preferable three to five times as large
- I Fundamental rejection filter usually required – mainly for GSM
- I Coupling device (conducted): directional coupler
- I Antenna (radiated): tuned dipole or reference antenna with known gain





# RSE - Radiated Spurious Emission (cont.)

## I Measurements on GSM requires notch filters

- I To prevent overload of the input stage of the receiver or SA
- I Internal or external pre-selectors or Yig filters are not enough !
- I Carrier signals from the device under test need to be notched
- I Even if no RF-Measurements are made directly at the carrier frequency, but close to them

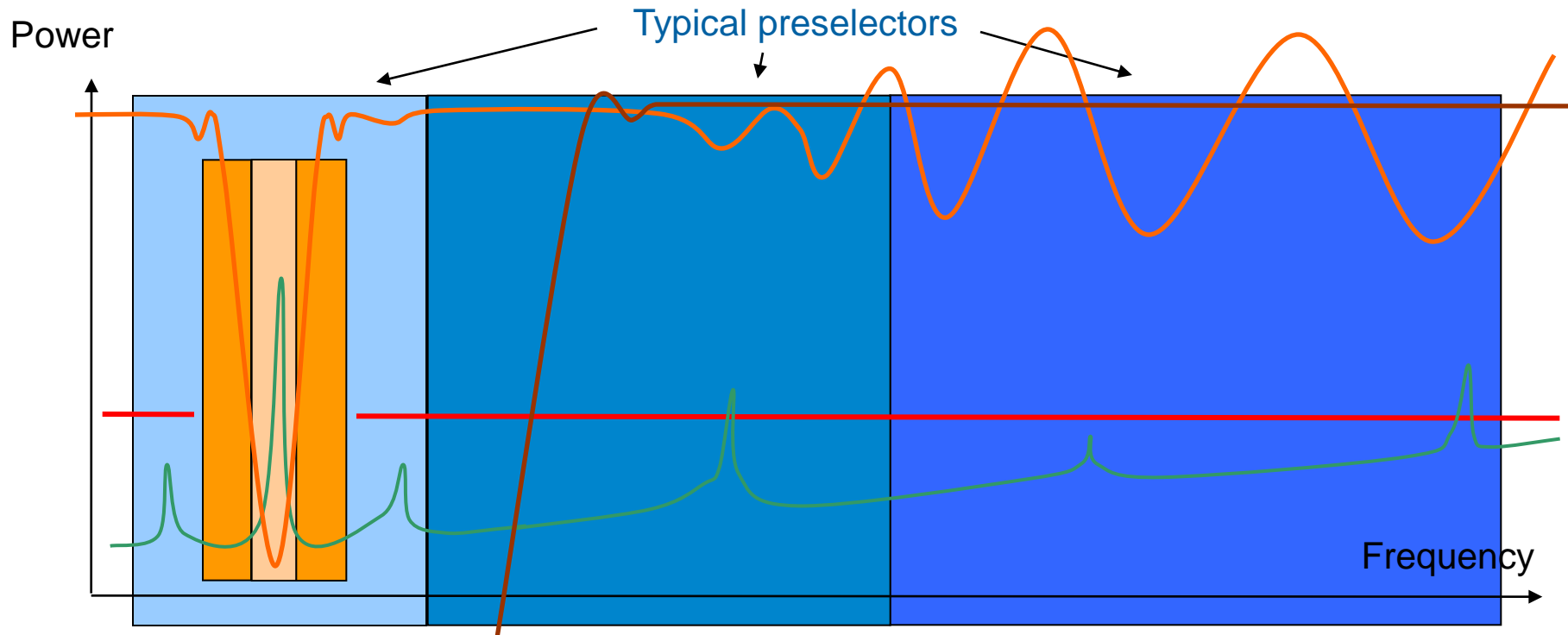

# RSE - Radiated Spurious Emission (cont.)

## Typ. test setup for radiated Emissions 30 MHz to 6 GHz

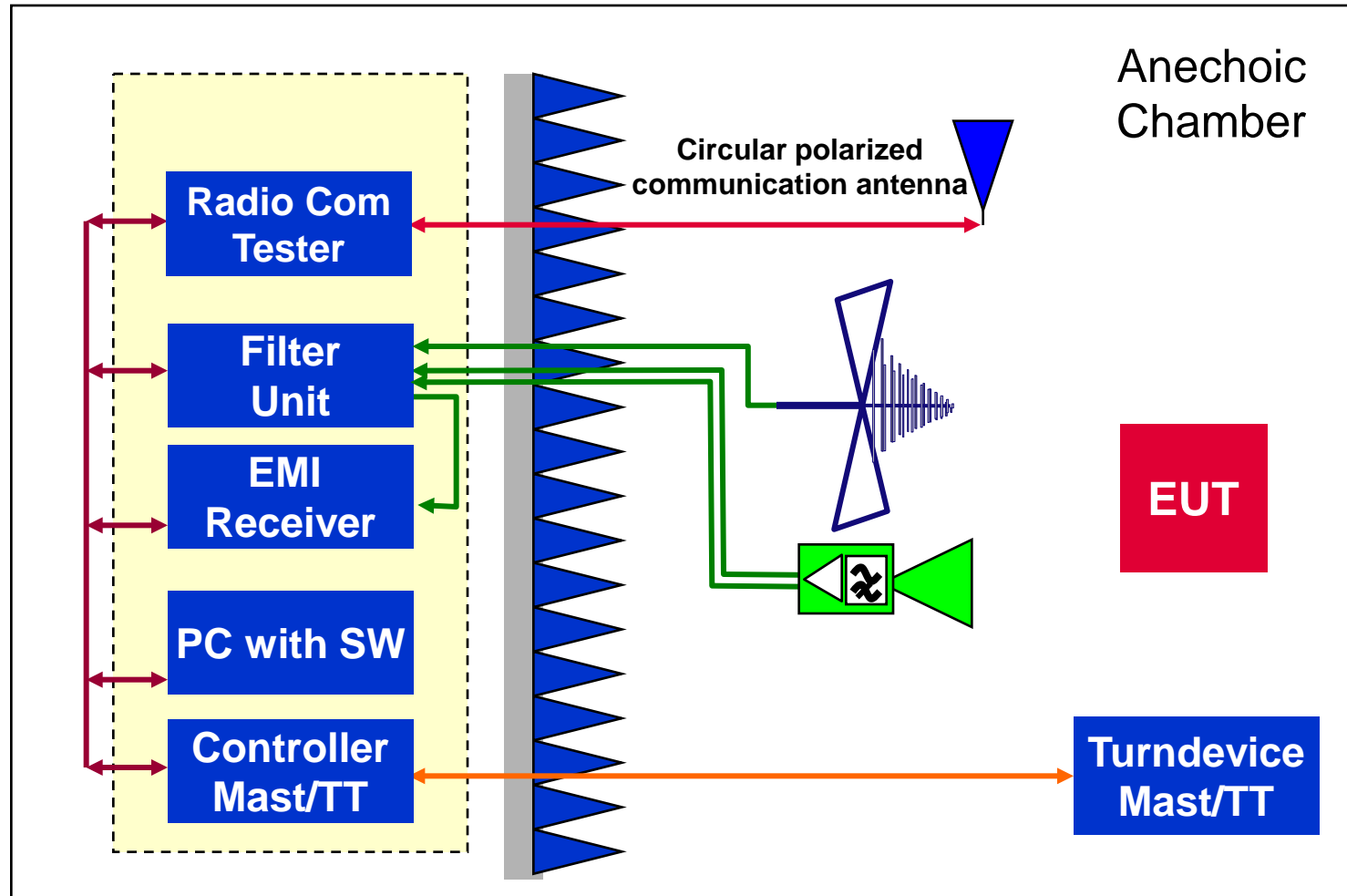

# RSE - Radiated Spurious Emission (cont.)

## Typ. test setup for radiated Emissions 6 GHz to 40 GHz

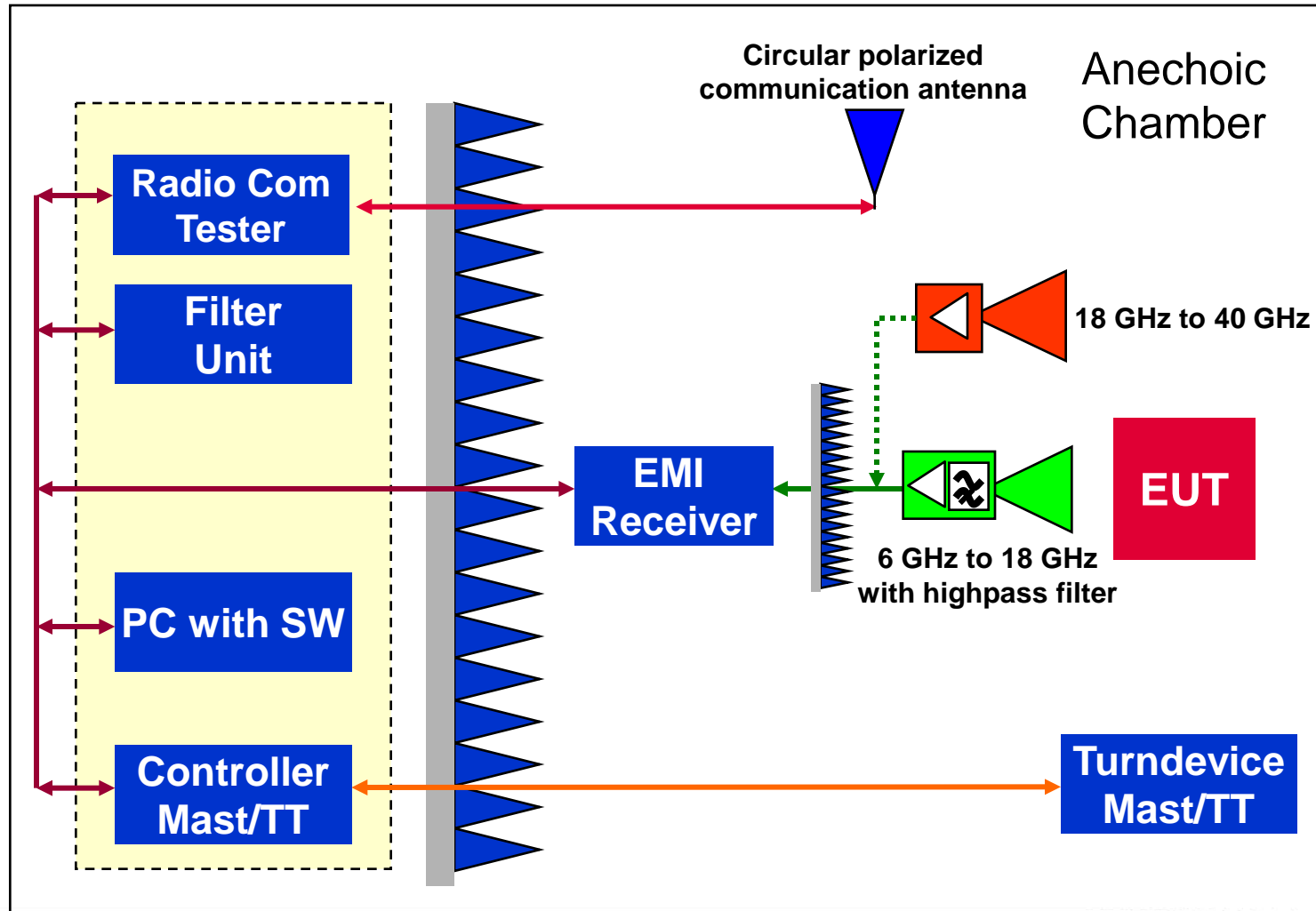

# RSE - Radiated Spurious Emission (cont.)

## I **Microwave Pre-amplifier Unit**

- I Frequency range 1 to 18 GHz
- I Directly attached to the antenna
- I 1st path: 1 to 6 GHz to filter unit
- I 2nd path: 6 to 18 GHz with filter and pre-amplifier

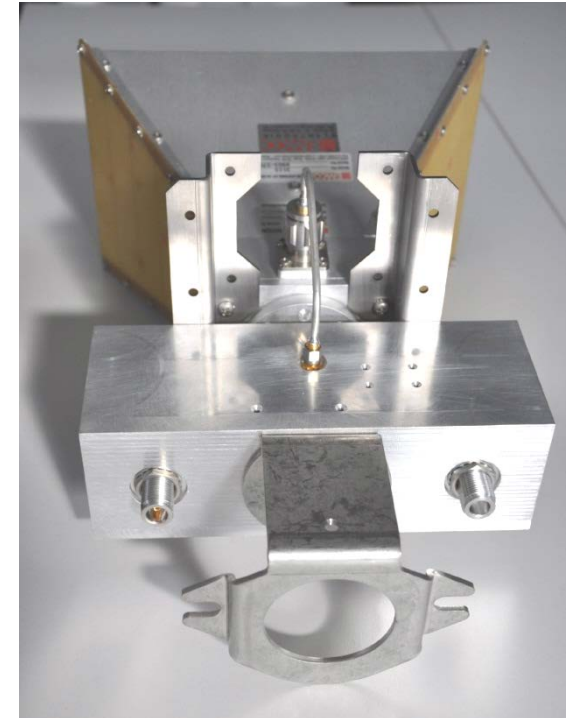

# RSE - Radiated Spurious Emission (cont.)

## | Example of a R&S®TS8996 RSE Test System

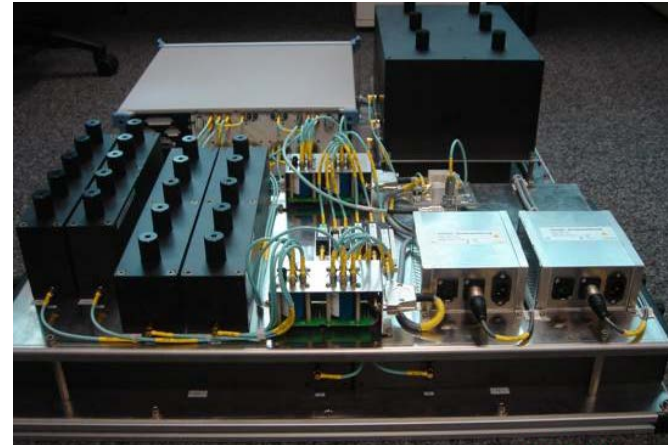

# RSE - Radiated Spurious Emission (cont.)

## I Changes to the filter system for 4G LTE

- I Due to the number of bands and bandwidth it is not really feasible to use notch filters
- I What to do?

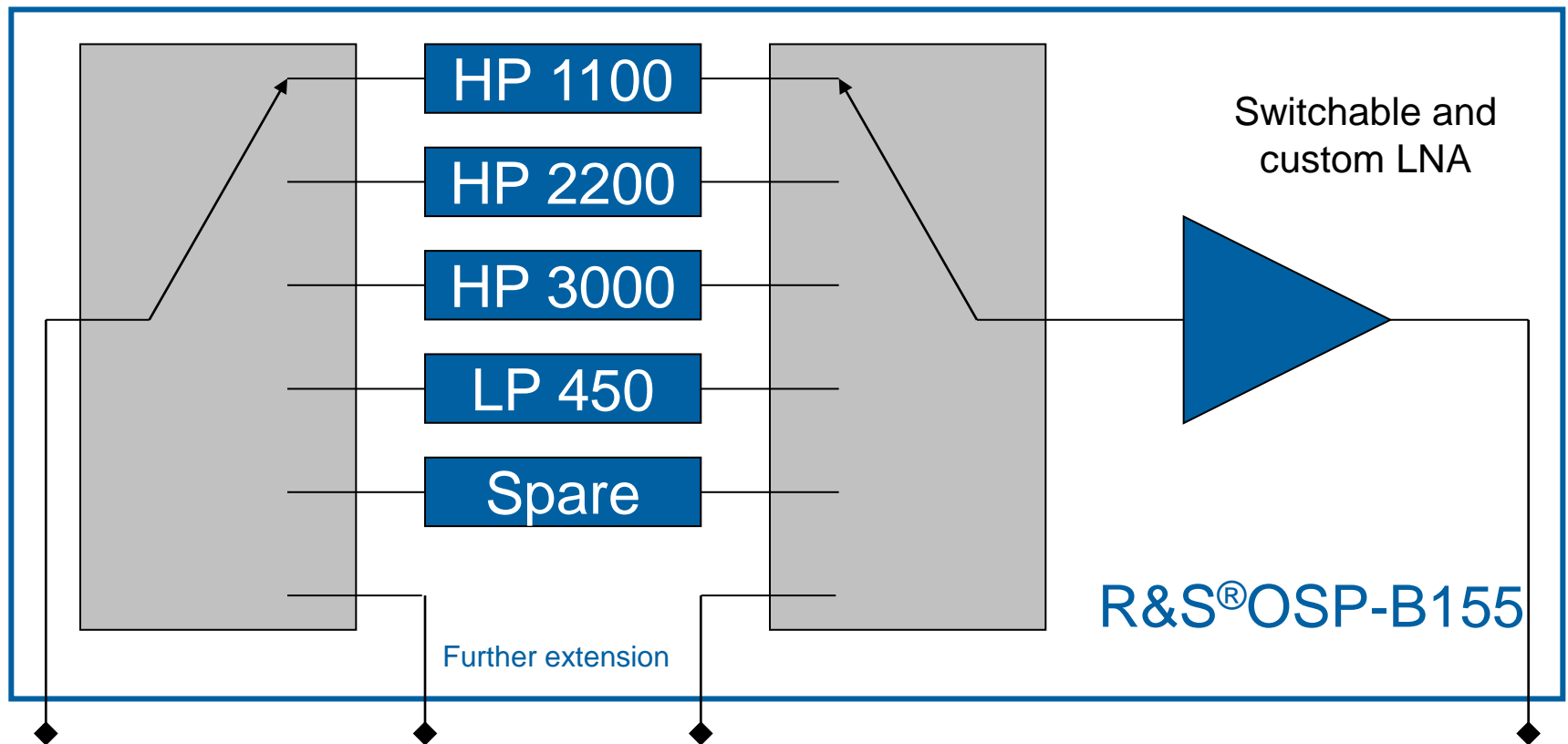

# RSE - Radiated Spurious Emission (cont.)

## I **Changes to the filter system for 4G LTE (cont.)**

- I The lower output power of LTE makes it possible to perform the measurements without a notch filter due to the high dynamic range of e.g. the R&S®ESU test receiver
- I The combination of switchable high pass and low pass filters and a custom LNA (Low Noise Amplifier) keeps the noise figure at a low level
- I A levelling procedure within e.g. R&S®EMC32 software in combination with optimized level balance of e.g. the R&S®OSP-B155 switch unit ensures the required optimum use of the dynamic range

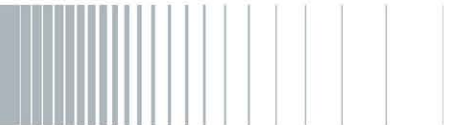

# RSE - Radiated Spurious Emission (cont.)

## I **RSE Summary**

- I Radiated Spurious Emission (RSE) Measurements of wireless devices are performed acc. to TS51.010 12.2.2 and relevant ETSI standards
- I All major communication standards need to be covered (GSM, WCDMA, CDMA, LTE)
- I For these RSE tests an anechoic chamber is required
- I EMC Measurements of wireless devices in Europe is performed according to the ETSI EN 301 489 Multipart standard
- I In USA devices have to comply to 47 CFR FCC Rules part 15

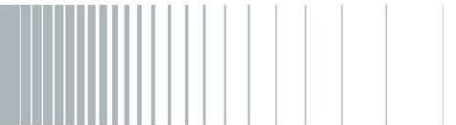



# Radiated Immunity Measurements

- | **Susceptibility test are e.g. described in**
  - | TS 34.124 (UE)
  - | ETSI EN 301 489-7
  - | Performance Criteria
    - In speech mode: (continuous phenomena)  
audio breakthrough uplink/downlink 35 dB below reference level
    - In data transfer mode:  
BER < 0.001 or BLER < 0.01 (data pattern to assess the Error Ratio are BER, BLER or end user data)
    - operate as intended
    - no loss of user control functions
    - no loss of stored data
    - communication link shall be maintained
    - no unintentional transmission (idle mode)

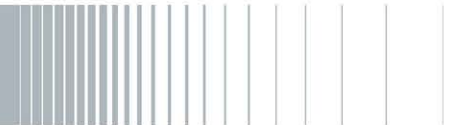

# Radiated Immunity Measurements (cont.)

## I Audio Breakthrough Measurement (speech mode)

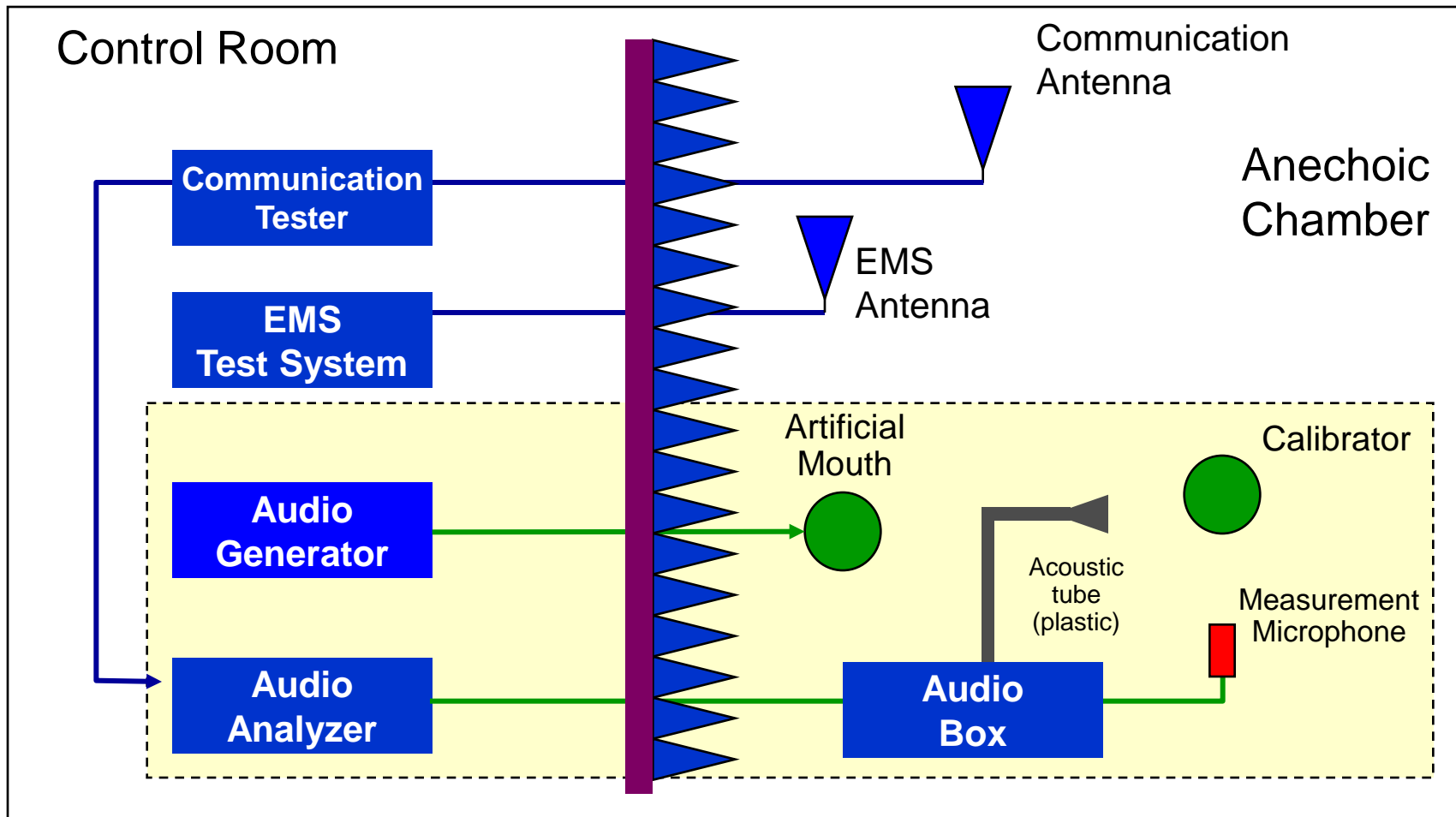

# Radiated Immunity Measurements (cont.)

## I BER Measurement (data transfer mode)

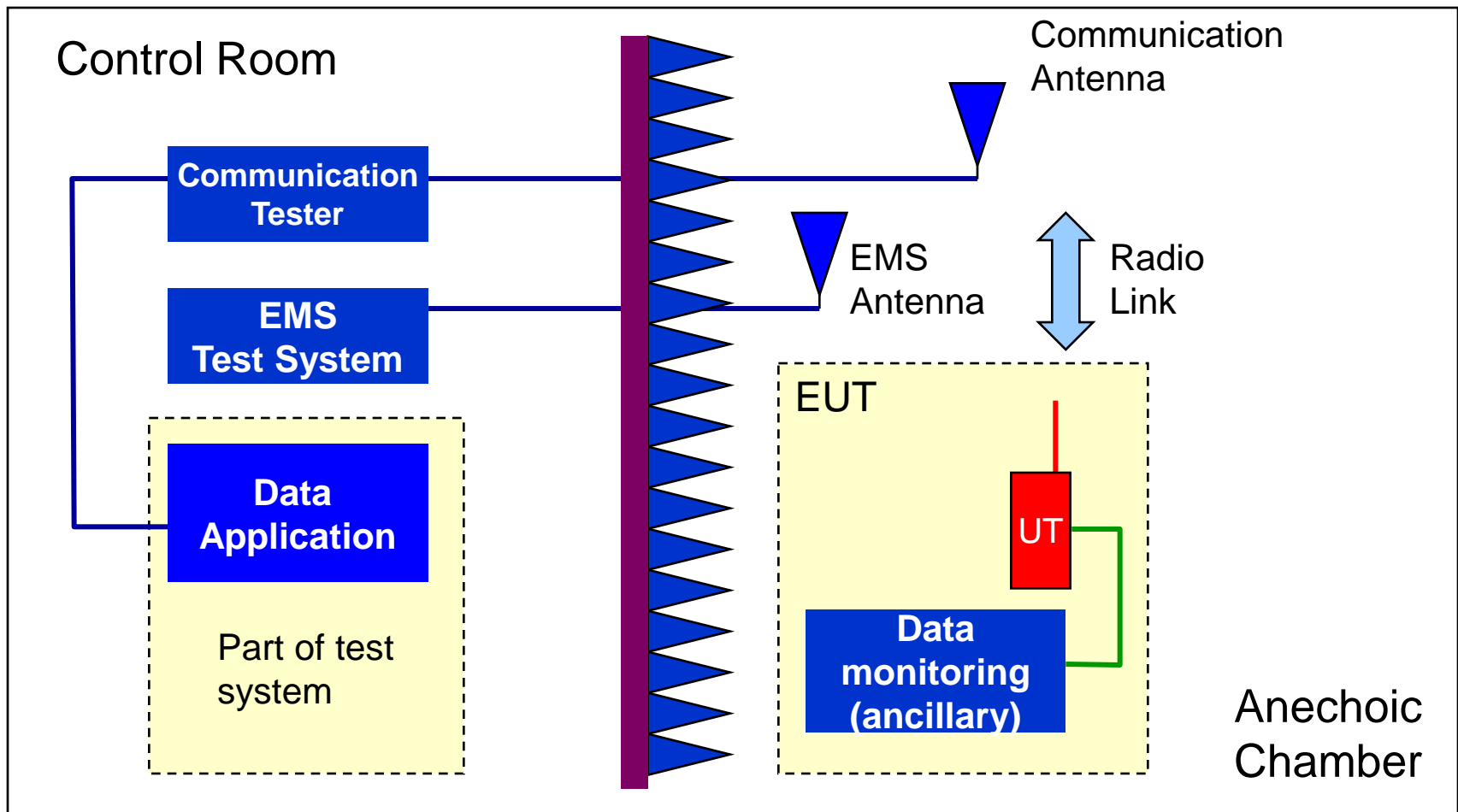

# Radiated Immunity Measurements (cont.)

## I Example of a Test System

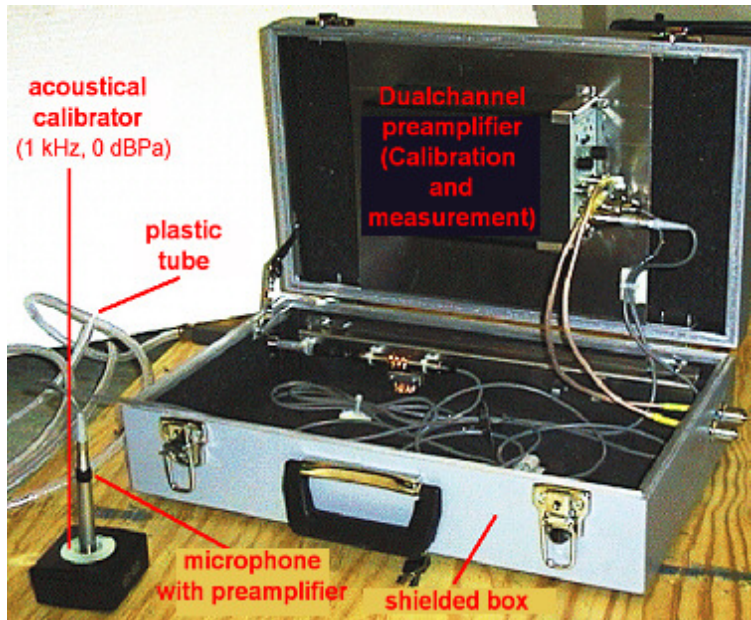

# Summary

- | **Radiated Immunity is only one of the immunity tests that need to be performed. Also transient immunity tests required (e.g. ESD, burst, surge, power fail)**
- | **ETSI standards are product family standards, they refer to generic standards (e.g. EN 61000-6-X) and basic standards (e.g. CISPR 22, CISPR 16, EN61000-4-x)**
- | **EMC Measurements of wireless devices are done in Europe according to ETSI EN 301 489-1 Multipart standard**
- | **Conformance tests - which are not typically EMC tests are required e.g. Conducted Spurious Emission, Power Density, Adjacent Channels and those under normal and extreme conditions**
- | **To follow all of those requirements a combination of Test Systems is required**

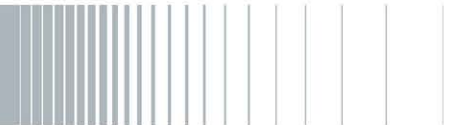

# Summary (cont.)



**Thank you for  
your attention**

**Questions?**

